



Solid Solutions. Smart Lighting.

# Duncan | Retail



# Duncan | Retail

The Duncan has been specially developed for use in shops, (car) showrooms and offices. Thanks to its design, the Duncan delivers a very even lighting pattern to aisles, shelves and ceilings. The option of a continuous line with direct and semi-indirect lighting is one of the most attractive features of the Duncan. The Duncan can be complemented with a wide range of spotlights that can be simply clicked onto the profile. With this system, Veko meets all your lighting wishes

## Veko has an eye for the future

If you wish to replace your existing lighting with energy-efficient LED lighting, then opting for Veko luminaires is the right choice. With Veko you are investing in a futureproof product. You can leave the profile in place and replace and/or add luminaires at any time without needing to adapt the system. And an additional positive point in terms of sustainability is that our lighting is supplied almost without packaging, and is 100% recyclable.

## Total Cost of Ownership

Based on Total Cost of Ownership (TCO), you have a clear overview of both the initial investment and the energy costs for the future. TCO helps you identify the ideal types of luminaires, sensors and/or the light management system.

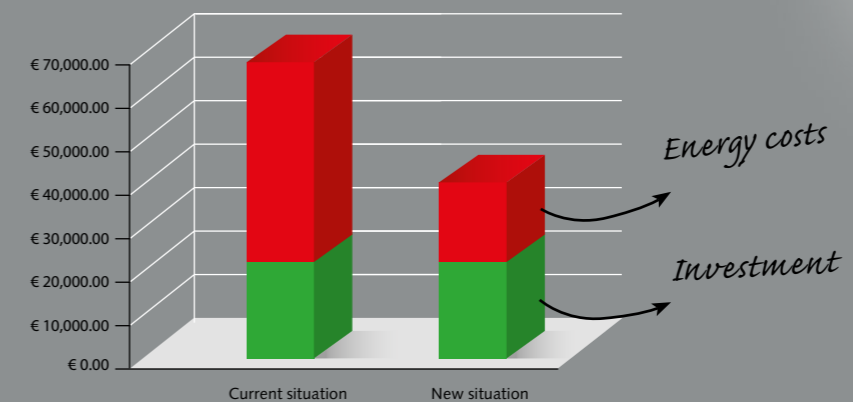

# Good lighting is the starting point

Retail, office and showroom lighting is all about atmosphere and customer experience. These can be achieved by playing with general and accent lighting. Our Duncan delivers the perfect linear light pattern in the aisles, with the option of adding spotlights to illuminate accented areas. Both types of luminaire are available in CRI90 and Tunable White, making them ideal for lighting fashion, food, automotive and general areas in an office environment.

## Wide

The Duncan Wide is the right choice for high retail buildings. Not only the shelf but also the aisle is optimally illuminated with the Wide lens. Due to its microprismatic design, the best possible distribution of light and the best conceivable protection against glare is offered.

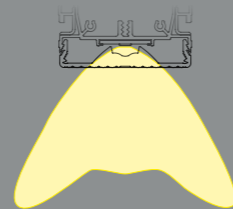

## Diffuse

The Diffuse lens on the Duncan delivers an attractive, even pattern, reducing the blinding effect to a minimum. The height of the lens ensures a partial indirect beam so that the ceiling is also attractively illuminated.

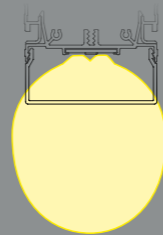

## Lambertian

For open spaces where visual comfort is important, the Lambertian offers the solution. This lens illuminates the entire surface and has a maximum even distribution. Due to its microprismatic design, the best possible distribution of light and the best conceivable protection against glare is offered.

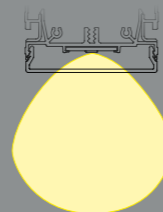

## Veko Focus Spot 36 degrees

The Veko Focus Spot has a 36-degree beam. This enables you to directly illuminate accents, and focus attention on a single specific product. This is often used as a single spotlight for direct lighting.



## Veko Highlight Spot 60 degrees

The Veko Highlight Spot has a 60-degree beam providing a wider and more generalised accent. This spotlight can be perfectly used to highlight a logo on a wall or a larger area. These spotlights are often used in sets of two, for cross-lighting.



# The light line in detail

We configure our light lines for every project. The light lines are designed stepwise, depending on the conditions required. In this way, we create a unique product, adapted to your project. This effect can be achieved with new light lines or by renovating existing Veko light lines.



## A smart system

The Duncan light line is a profile system developed individually for each project. This enables you to create the ideal combination of continuous light lines interspersed with spotlights. Central emergency lighting, DALI sensors and marketing applications like YellowDot can be easily added. If you opt for a profile with cable duct, other cables can easily be integrated.

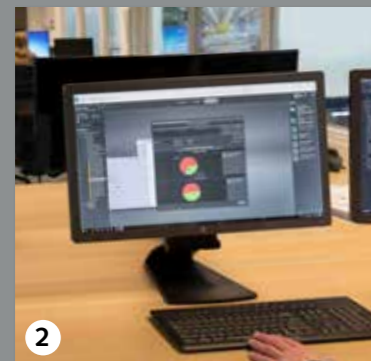

## Encelium light management system

Using the Encelium light management system (from Osram) you can easily manage your (emergency) lighting and sensors. The system generates reports with fault messages, the latest energy consumption data and energy savings, all visualised in a 3D plan.

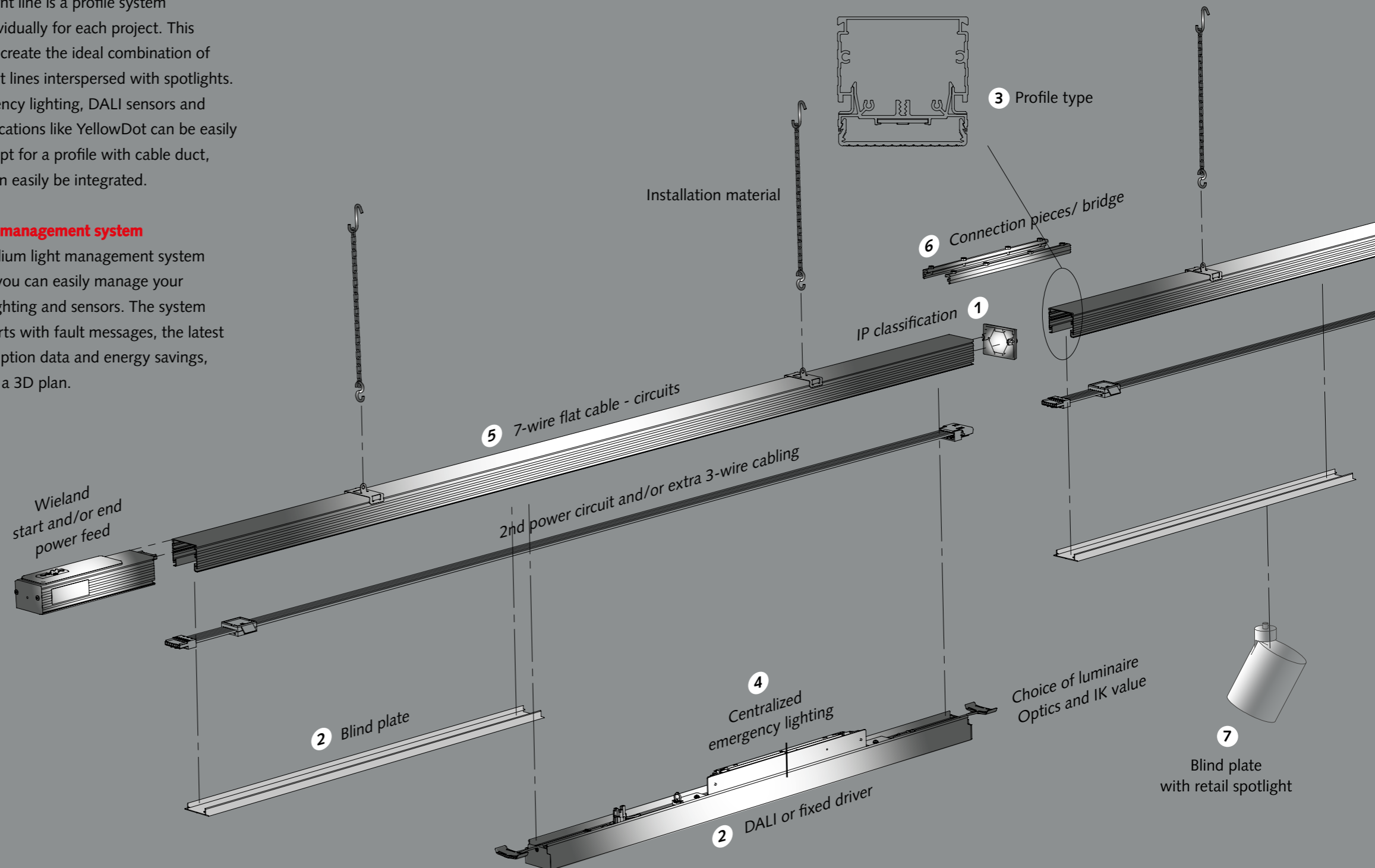
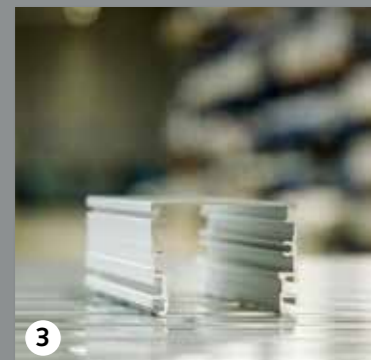

# From design to maintenance

Veko are specialists in linear lighting. The company develops and manufactures LED lighting in-house. As far as possible, we remove all our customers' cares and deliver turn-key projects. From application to maintenance, you can rely on the specialists at Veko.



## Development

Every day, a team of designers and product engineers at Veko is working very hard developing, testing and producing the latest industrial lighting products. Veko aims to deliver the ideal lighting solution for every factory hall, sports hall, carpark, refrigerated and frozen storage location and retail environment. Through the use of separate lenses, Veko identifies the ideal optical solution. One special feature is that whereas Veko used to purchase all components, the company now manufactures the light sources itself, in combination with smart switching systems. Thanks to Veko Tune, luminaires are adapted precisely to your specific wishes.



## Production

Veko operates a modern factory and also manufactures its own LED strips. Veko even produces 1.5 metre-long LED boards eradicating annoying interruptions in the lighting pattern. In the factory in Schagen, luminaires are produced on a project basis and delivered fully prefabricated.



## Installation

Engineers at Veko work in fixed teams and take up the challenge to install your lighting as efficiently as possible. Because they handle linear lights on a daily basis, and the systems are delivered plug and play, you experience minimal nuisance on the shop floor and save up to 50% on installation times.



The Veko team will also be happy to remove your existing lighting. This fact, combined with the minimal use of packaging material guarantees that your location can be put back into action quickly and cleanly.

## Service and maintenance

If something does go wrong with your system, the service staff are permanently on call. Veko handles all light disruptions from a central location, guaranteeing rapid, adequate assistance.



# Reference projects

Over the past few years, Veko has completed numerous eye-catching projects based on our innovative luminaires, backed up by the latest technology. We are proud to share the results and findings of our customers.

## Budget Food

This supermarket discounter, with numerous stores throughout the Netherlands, sells well-known brands at remarkably low prices. How do you light a budget supermarket? Using super energy-efficient LED lighting from Veko, of course.

## Alvo Supermarket

For a brand-new supermarket location, Alvo called in the expertise of Veko. The light lines deliver additional allure to this attractive retail location.

## Decathlon

Linear lighting is becoming increasingly popular in stores. In the brand-new Decathlon store in Alkmaar, Veko has installed its two-meter-long LED linear luminaire. In total, 800 metres of luminaires were installed in just three days.

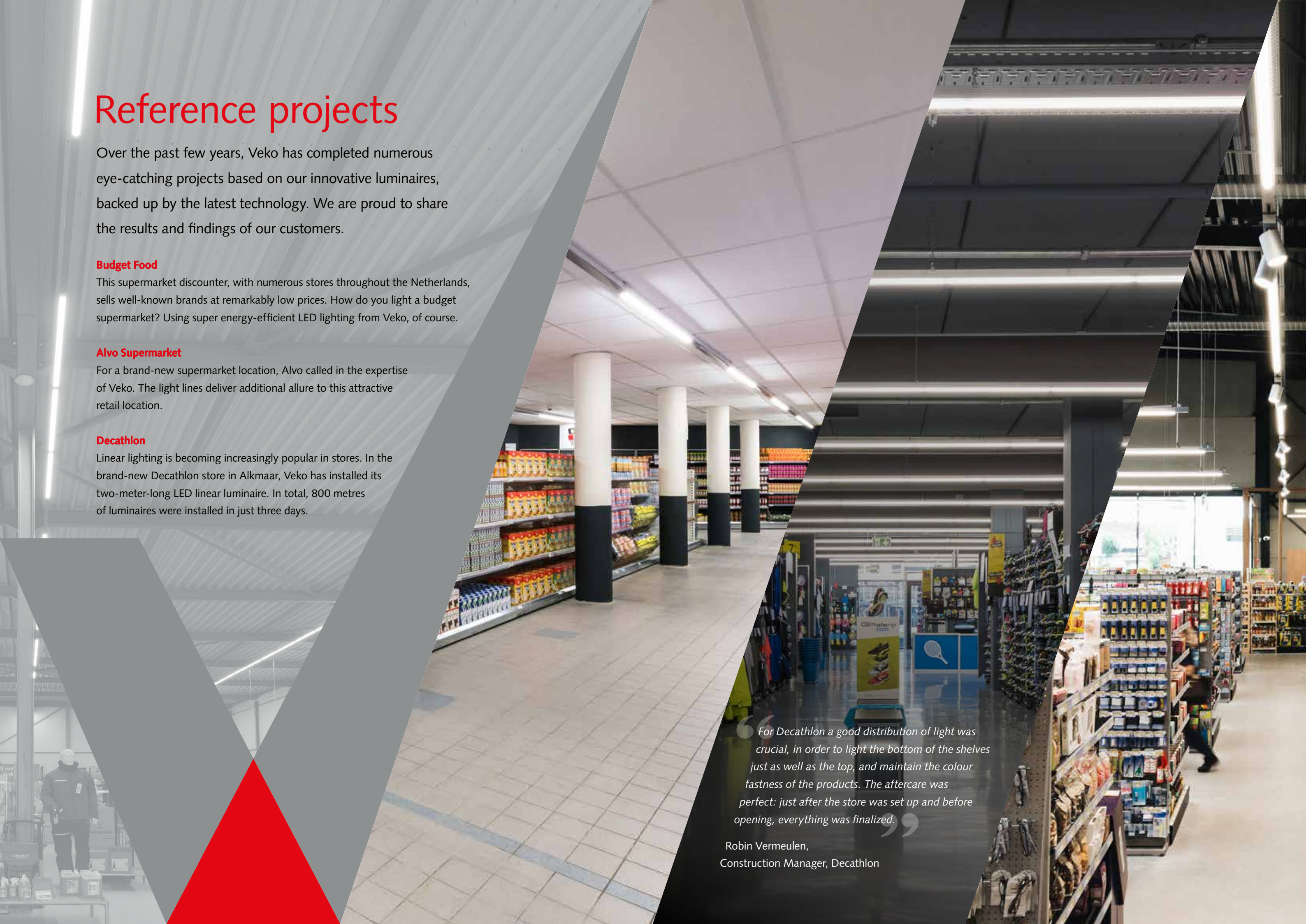

“For Decathlon a good distribution of light was crucial, in order to light the bottom of the shelves just as well as the top, and maintain the colour fastness of the products. The aftercare was perfect: just after the store was set up and before opening, everything was finalized.”

Robin Vermeulen,  
Construction Manager, Decathlon



Solid Solutions. Smart Lighting.

[www.veko.com](http://www.veko.com)